

PIXELINE flex



One of a kind **Bold & flexible**

Patented **modular design**

Unmached **long run**



Bold & flexible

40mm wide

- Light surface delivers bold visibility up close and excellent direct-view impact from a distance.

Flexibility

- Available with curved or flat top cover options, offering both front and side bending to follow any design.

long run

- Light engine lengths up to 10 m (RGBW DMX) and cover lengths up to 30 m for continuous, seamless illumination.



Modular 2-part design

Seamless

- Cable and light engine can be offset from the cover, allowing virtually unlimited lengths with no visible seams.

Reusable

- Separated light engine can be paired with different cover options, adapting to multiple applications.

Repairable

- Individual segments can be swapped without dismantling the full run.



Light engine options

Single color

- available from 2700K to 6500K

TW

- 2700K -> 6500K

RGBTW

- RGB + 2700K -> 6500K

DMX-RGBW

- RGB + 3000K pixel controlled

Lm/m	Lm/W	W/m	CRI
1276	68	19	95
2260	108	21	95
1235	61	20	95
460	22	20	95

Specs are produced using the VNL-F40F-24-C cover + light engines

For latest and more product specs please refer to the datasheet found on vivalyte.com

Cover options

VNL-F40F-24-C

- Front bending, flat surface.

VNL-F40C-24-C

- Front bending, curved surface.

VNL-S40F-24-C

- Side bending, flat surface.

Frontbending

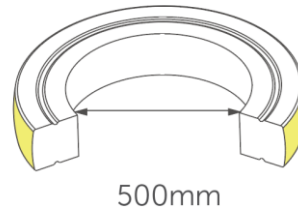

40mm



Flat surface

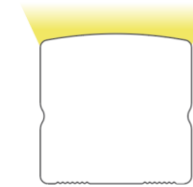

24V(DC)



Frontbending

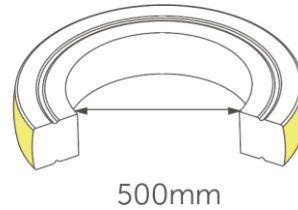

40mm



Curved surface



24V(DC)



Side Bending

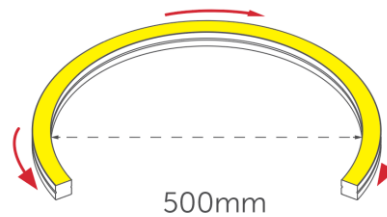

40mm



Flat surface

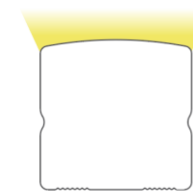

24V(DC)



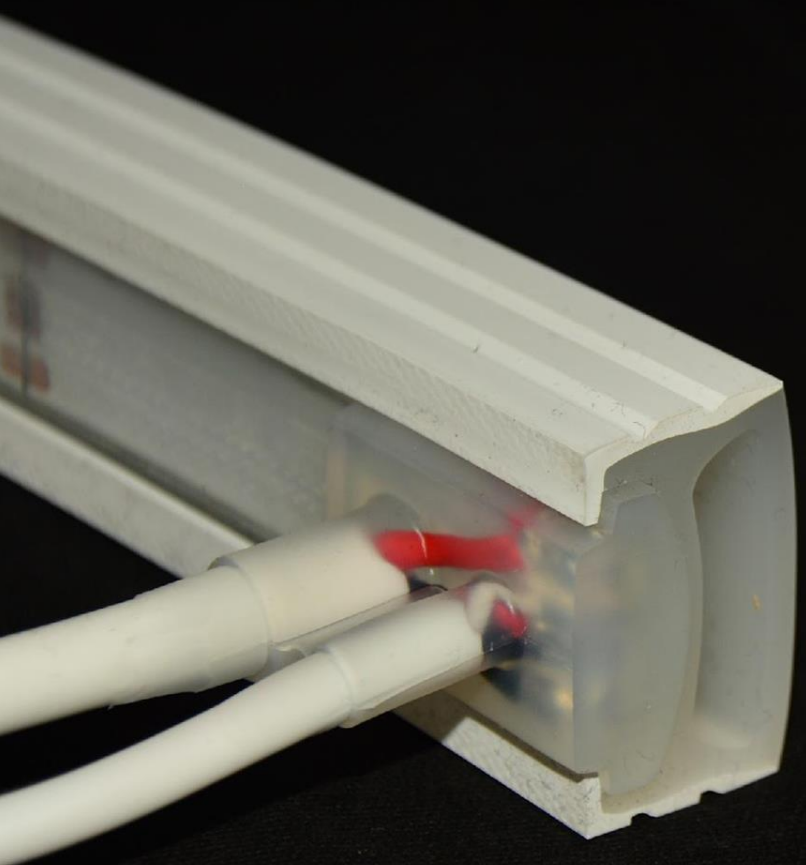

VNL-F40F-24

Front bending 40mm wide linear light

With a flat top surface

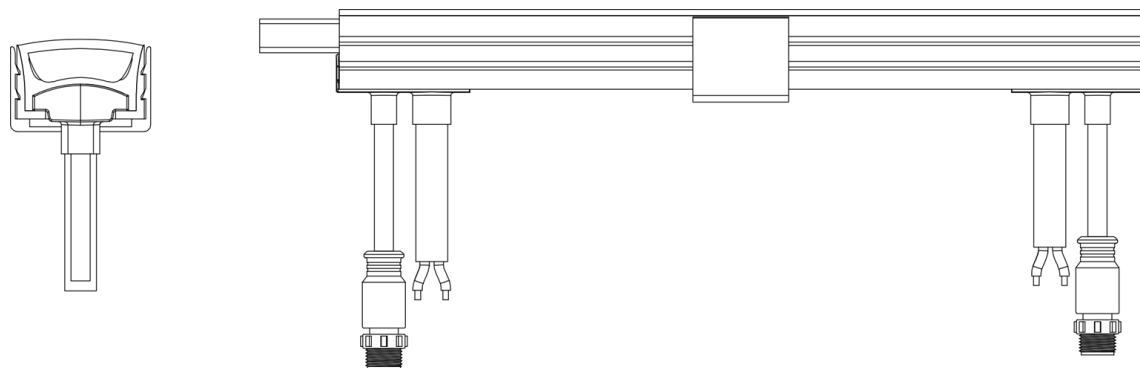

Cover Connector
VNL-F40F-24-CIC



End Cap
VNL-F40F-24-CEC



Clip
VNL-F40F-24-AP
Standard mounting profile.
Recommended for when the profile is visible



Clip V2
VNL-F40F-24-APS
Slim mounting profile.
Recommended for recessed installation.



VNL-F40C-24

Front bending 40mm wide linear light

With a flat top surface

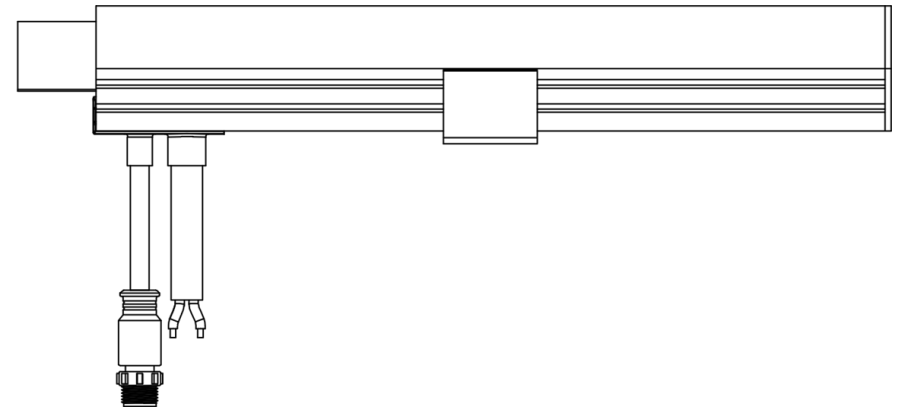
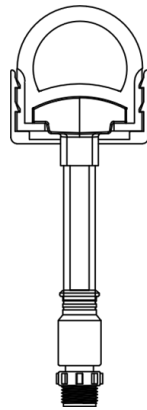

Cover Connector

VNL-F40C-24-CIC



End Cap

VNL-F40C-24-CEC

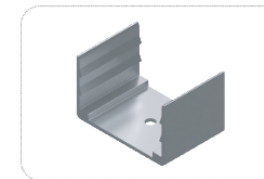

Clip

VNL-F40C-24-AP

Standard mounting profile.
Recommended for when the profile is visible.

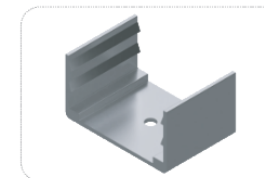

Clip V2

VNL-F40C-24-APS

Slim mounting profile.
Recommended for recessed installation.



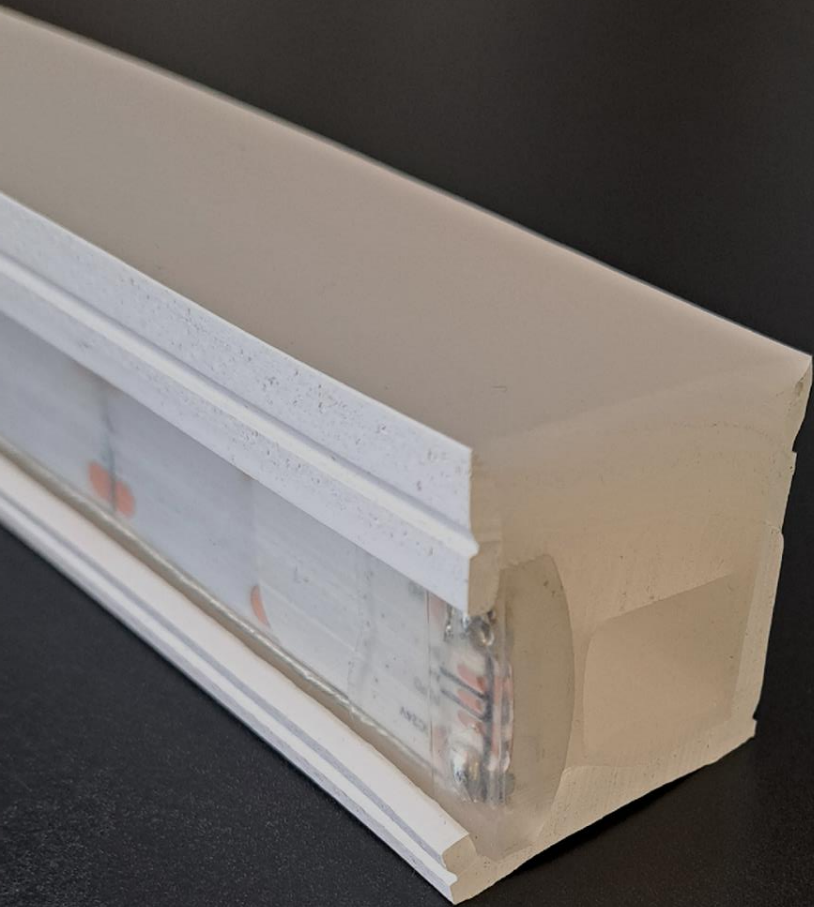

VNL-S40F-24

Side bending 40mm wide linear light

With a flat top surface

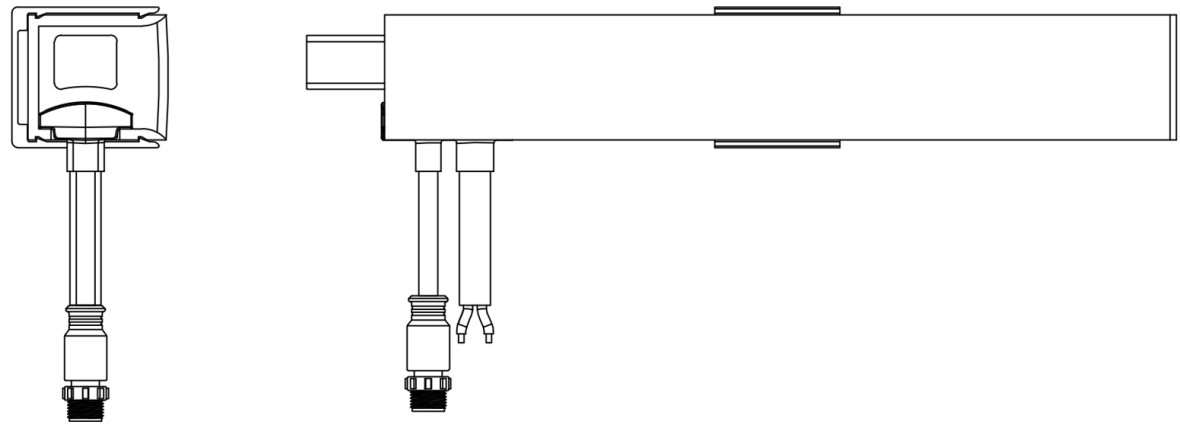

Cover Connector
VNL-S40F-24-CIC

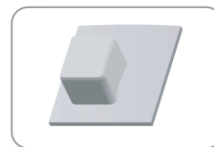

End Cap
VNL-S40F-24-CEC

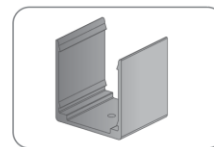

Clip
VNL-S40F-24-AP

